

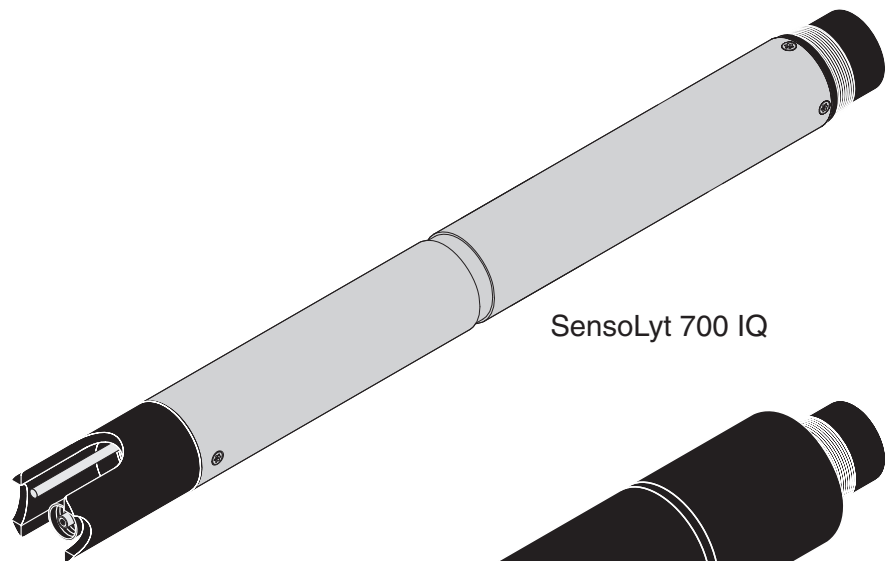

a xylem brand

Operating manual

IQ SENSOR NET SensoLyt[®] 700 IQ (SW)



SensoLyt 700 IQ

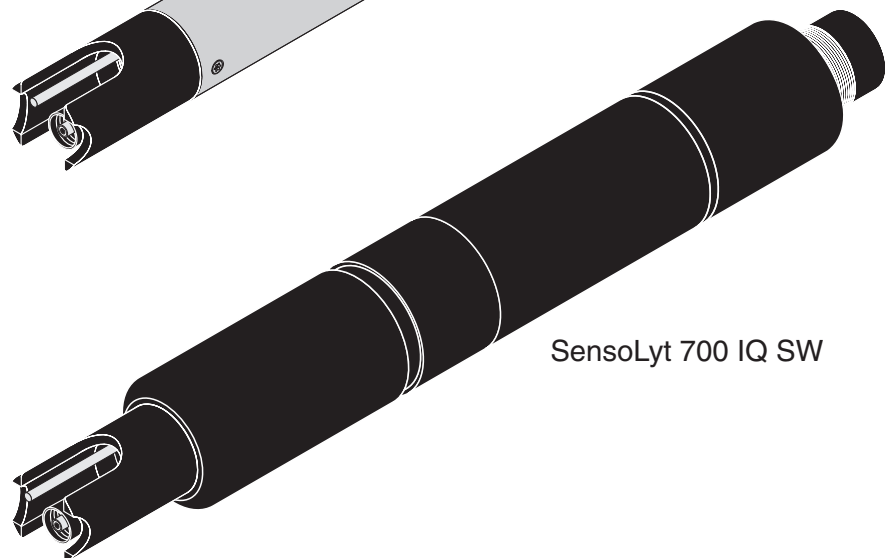

SensoLyt 700 IQ SW

IQ SENSOR NET pH/ORP sensor



Note

For the most recent version of the manual, please visit www.ysi.com.

Contact

YSI
1725 Brannum Lane
Yellow Springs, OH 45387 USA
Tel: +1 937-767-7241
800-765-4974
Email: environmental@ysi.com
Internet: www.ysi.com

Copyright

© 2012 Xylem Inc.

Sensolyt® 700 IQ (SW) - Contents

1	Overview	1-1
1.1	How to use this component operating manual	1-1
1.2	Structure of the Sensolyt® 700 IQ (SW)	1-2
1.3	Recommended fields of application	1-2
2	Safety	2-1
2.1	Authorized use	2-2
2.2	General safety instructions	2-2
3	Commissioning	3-1
3.1	Scope of delivery	3-1
3.2	Installation	3-1
3.3	Commissioning / Getting the instrument ready for measuring	3-3
3.4	Sensolyt® 700 IQ (SW) setting table	3-6
4	Measuring / Operation	4-1
4.1	Measuring	4-1
4.2	Calibration	4-1
4.2.1	General information on calibration	4-1
4.2.2	Calibration with <i>CAL TEC AUTO</i>	4-3
4.2.3	Calibration with <i>CAL CON 2P</i>	4-4
4.2.4	Calibration with <i>CAL CON 1P</i>	4-5
4.2.5	Calibration result	4-6
4.2.6	Calibration history	4-7
4.2.7	Reactivation of the last valid calibration	4-8
5	Maintenance and changing the electrode	5-1
5.1	General maintenance instructions	5-1
5.2	Replacing the combination electrode	5-2
5.3	Disposal	5-4
6	Replacement parts and accessories	6-1
6.1	Combination electrodes	6-1
6.2	General accessories	6-1
7	What to do if...	7-1

8	Technical data	8-1
8.1	Measurement characteristics	8-1
8.2	Application characteristics	8-1
8.3	General data	8-3
8.4	Electrical data	8-4
9	Contact Information	9-1
9.1	Ordering & Technical Support	9-1
9.2	Service Information	9-1
10	Indexes	10-1
10.1	Explanation of the messages	10-1
10.1.1	Error messages	10-1
10.1.2	Info messages	10-2
10.2	Status info	10-3

1 Overview

1.1 How to use this component operating manual

Structure of the IQ SENSOR NET operating manual

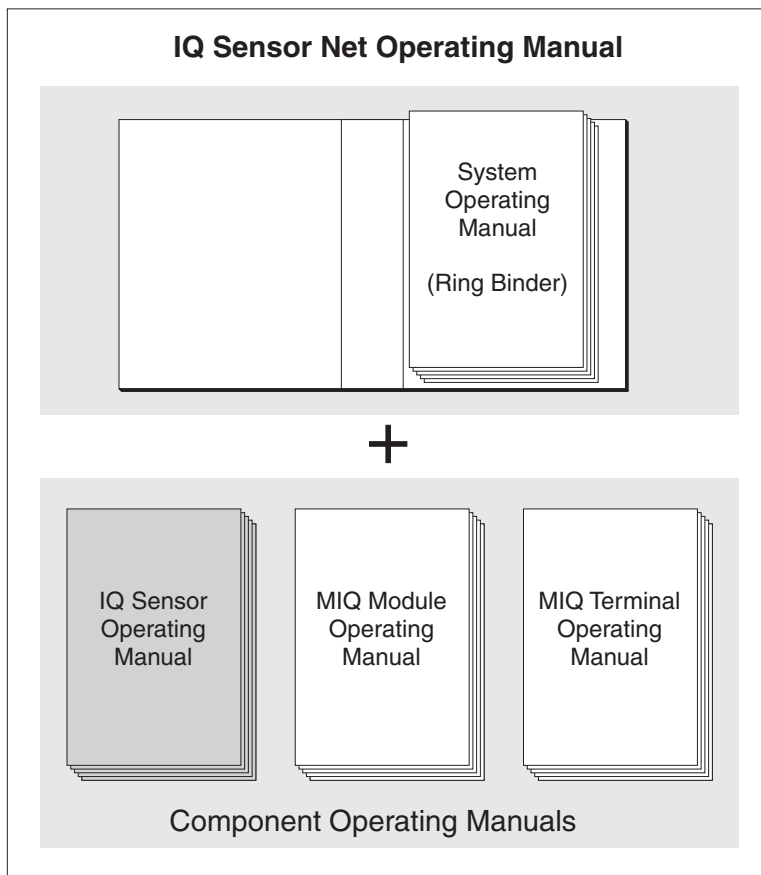

Fig. 1-1 Structure of the IQ SENSOR NET operating manual

The IQ SENSOR NET operating manual has a modular structure like the IQ SENSOR NET system itself. It consists of a system operating manual and the operating manuals of all the components used.

Please file this component operating manual in the ring binder of the system operating manual.

1.2 Structure of the SensoLyt® 700 IQ (SW)

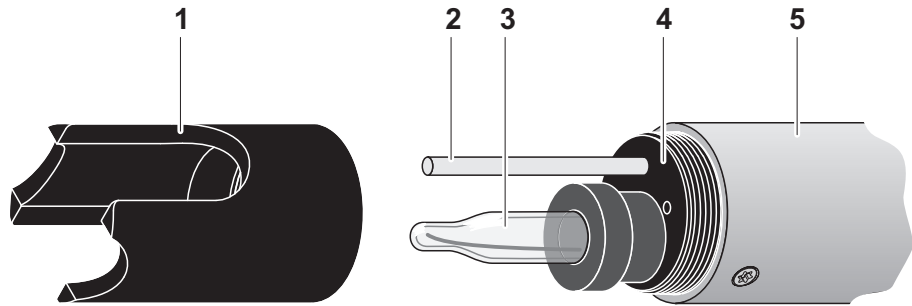

Fig. 1-2 Structure of the pH/ORP sensor (example, SensoLyt® 700 IQ)

1	Protective hood
2	Temperature sensor
3	Combination electrode (not contained in the scope of delivery)
4	Electrode holder
5	Sensor shaft



Note

The pH combination electrodes that can be used are available as accessories (see chapter 6 REPLACEMENT PARTS AND ACCESSORIES).

Screening of the pH/ORP sensor

The combination electrode and the SensoLyt® 700 IQ pH/ORP sensor together with the IQ SENSOR NET system form a measuring system that is protected to a high degree against low and high frequency interference as well as against the indirect effects of lightning strikes.

Glass breakage monitoring

The sensor is equipped with a SensCheck function for monitoring glass breakage.

1.3 Recommended fields of application

In conjunction with the SensoLyt® SEA, SensoLyt® DWA and SensoLyt®, ECA pH combination electrodes as well as the SensoLyt® PtA ORP combination electrode, the SensoLyt® 700 IQ pH/ORP sensor is suitable for stationary pH or ORP measurement in the following ranges.

SensoLyt 700 IQ

Stationary measurements in water/wastewater applications.

SensoLyt 700 IQ SW

Stationary measurements in seawater and brackish water, aquaculture.

2 Safety

This component operating manual contains special instructions that must be followed in the operation of the Sensolyt® 700 IQ (SW) pH/ORP sensor. Thus, it is essential to read this component operating manual before carrying out any work using this sensor. In addition to this manual, the SAFETY chapter of the IQ SENSOR NET system operating manual must be followed.

Always keep this component operating manual together with the system operating manual and any other component operating manuals in the vicinity of the IQ SENSOR NET system.

Special user qualifications

The pH/ORP sensor was developed for applications in online measurement - essentially in the field of wastewater treatment. Thus, we assume that the operators are familiar with the necessary precautions to take when dealing with chemicals as a result of their professional training and experience.

General safety instructions

Safety instructions in this operating manual can be recognized by the warning symbol (triangle) in the left column. The signal word (e. g. "CAUTION") indicates the level of the danger:



WARNING

indicates instructions that must be followed precisely in order to prevent serious dangers to persons.



CAUTION

indicates instructions that must be followed precisely in order to avoid slight injuries or damage to the instrument or the environment.

Other labels



Note

indicates notes that draw your attention to special features.



Note

indicates cross-references to other documents, e.g. operating manuals.

2.1 Authorized use

The authorized use of the SensoLyt® 700 IQ (SW) comprises its use as a pH/ORP sensor together with a pH combination electrode or ORP combination electrode in the IQ SENSOR NET.

The technical specifications according to chapter 8 TECHNICAL DATA must be observed. Only operation according to the instructions in this operating manual is authorized.

Any other use is considered to be **unauthorized**. Unauthorized use invalidates any claims with regard to the guarantee.



CAUTION

Only connect and operate the sensor together with IQ SENSOR NET accessories.

2.2 General safety instructions

The sensor left the factory in a safe and secure technical condition.

The failure-free function and operational safety of the sensor is only guaranteed if the generally applicable safety measures and the special safety instructions in this operating manual are followed during its use.

The failure-free function and operational safety of the sensor is only guaranteed under the environmental conditions that are specified in chapter 8 TECHNICAL DATA.

The specified temperature (chapter 8 TECHNICAL DATA) must be maintained during the operation and transport of the sensor. Protect the sensor, particularly against frost or overheating.



CAUTION

The sensor may only be opened by specialists authorized by YSI.

Function and operational safety

Safe operation

If safe operation is no longer possible, the sensor must be taken out of operation and secured against inadvertent operation.

Safe operation is no longer possible if the sensor:

- has been damaged in transport
- has been stored under adverse conditions for a lengthy period of time
- is visibly damaged
- no longer operates as described in this manual.

If you are in any doubt, contact the supplier of your sensor.

Obligations of the operator

The operator of the sensor must ensure that the following rules and regulations are followed when dealing with hazardous substances:

- EEC directives for protective labor legislation
- National protective labor legislation
- Safety regulations
- Safety data sheets of the chemical manufacturer.

3 Commissioning

3.1 Scope of delivery

- SensoLyt® 700 IQ (SW)
- The sensor is fitted with a protective hood and protective caps
- Operating manual.

3.2 Installation

Connection cable

A sensor connection cable of the SACIQ or SACIQ SW type is required to connect the sensor. The cable is available in different lengths. Compared to the standard model SACIQ, the SACIQ SW sensor connection cable is optimized regarding its corrosion resistance in seawater and brackish water and adapted for use in conjunction with the SensoLyt® 700 IQ SW. Information on this and other IQ SENSOR NET accessories is given in the YSI catalog and on the Internet.



Note

How to connect the SACIQ (SW) sensor connection cable to the terminal strip of an MIQ module is described in chapter 3 INSTALLATION of the IQ SENSOR NET system operating manual.



CAUTION

The SensoLyt® 700 IQ pH/ORP sensor unit may only be immersed in conjunction with a mounted combination electrode. Moisture must be prevented from penetrating the pH/ORP sensor during the replacement of the electrode as, otherwise, the sensor could be destroyed. Which electrodes can be used in conjunction with the SensoLyt® 700 IQ pH/ORP sensor unit is given in section 6.1 COMBINATION ELECTRODES.

Are the plug connections dry?

Before connecting the sensor and sensor connection cable, please make sure that the plug connections are dry. If moisture gets into the plug connections, first dry the plug connections (dab them dry or blow them dry using compressed air).



Note

Do not suspend the sensor on the sensor connection cable. Use an armature or electrode holder. Information on this and other IQ SENSOR NET accessories is given in the YSI catalog and on the Internet.

**Connecting the sensor
to the sensor
connection cable**

1	Take the protective caps off the plug connections of the sensor and the SACIQ (SW) sensor connection cable and keep them safe.
2	Plug the jack of the SACIQ (SW) sensor connection cable onto the plug head connector of the sensor. At the same time, rotate the socket so that the pin in the plug head connector (1) clicks into one of the two holes in the jack.
3	Then, screw the coupling ring (2) of the sensor connection cable onto the sensor up to the stop.

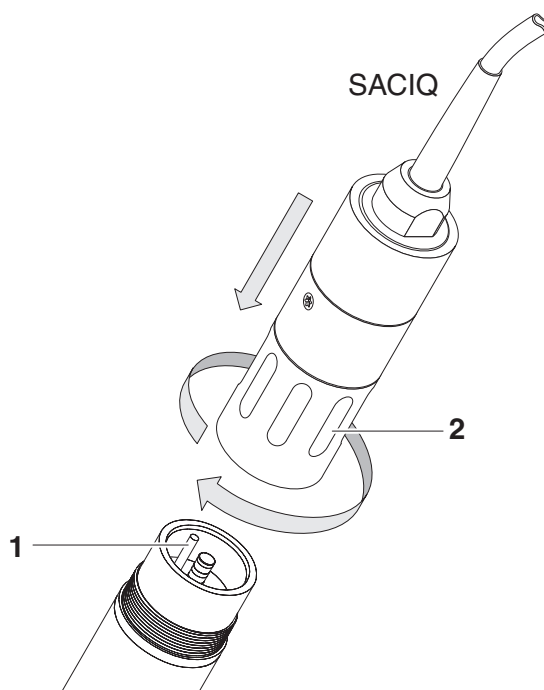

Fig. 3-1 Connecting the sensor

3.3 Commissioning / Getting the instrument ready for measuring



Note

A KCl-filled plastic cap is mounted on the tip of the sensor to keep the combination electrode active during storage (or during longer pauses in measuring). The cap must be removed for measuring.

Mounting the combination electrode

- 1 | Unscrew the protective hood from the sensor.

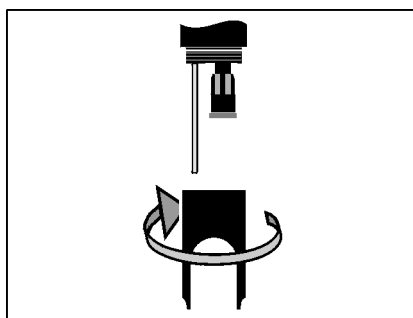

- 2 | Pull off the blind plug from the plug head socket of the sensor.

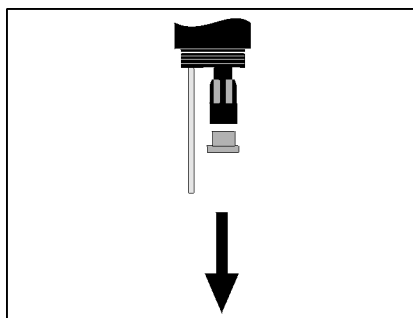

- 3 | Screw off the protective cap of the plug head connector of the combination electrode.

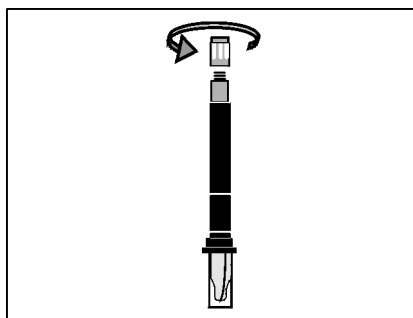

- 4 | Screw the combination electrode into the plug head socket of the sensor.

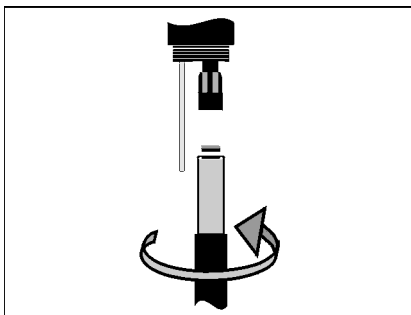

- 5 | Push the unit into the sensor up to the stop.

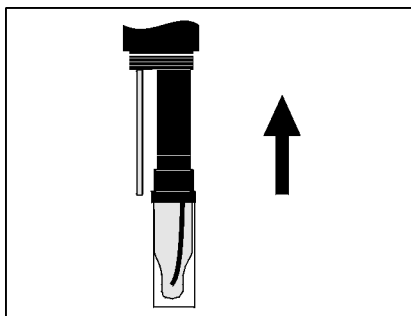

CAUTION

Push the connected combination electrode into the sensor right up to the stop so that the connection is watertight. Leaks could lead to the destruction of the sensor.

- 6 | Pull the KCl-filled plastic cap off the combination electrode for measuring.

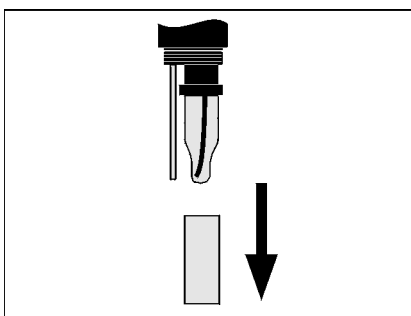

7 | Screw the protective hood onto the sensor.

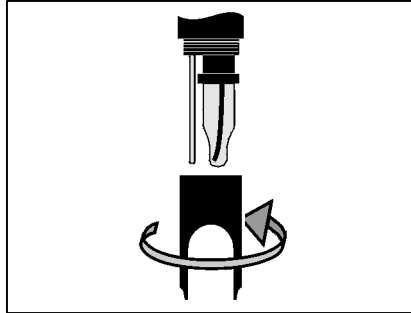

8 | If required, assign a user-defined name to the sensor (see relevant IQ SENSOR NET system operating manual).

9 | Set the sensor (see section 3.4).

10 | Calibrate the sensor (see section 4.2).

3.4 Sensolyt® 700 IQ (SW) setting table

Setting	Selection/values	Explanation
<i>Measuring mode</i>	<ul style="list-style-type: none"> ● <i>mV</i> ● <i>pH</i> 	Unit of the measured values on the measured value display.
<i>Temperature mode</i>	<ul style="list-style-type: none"> ● °C ● °F 	Unit of the measured temperature value (Celsius, Fahrenheit).
<i>Calibration procedure</i> (only in pH measuring mode)	<ul style="list-style-type: none"> ● <i>CAL TEC AUTO</i> ● <i>CAL CON 2P</i> ● <i>CAL CON 1P</i> 	<ul style="list-style-type: none"> ● Simplified 2-point calibration using any two different buffer solutions. The nominal values of the buffer solutions are stored in the sensor. This makes the manual entry of the nominal values redundant. ● 2-point calibration using the following buffer solutions: 1.) pH 7.0 ± 0.5 2.) any pH value The nominal values of the buffer solutions must be entered. ● 1-point calibration using any single buffer solution. The nominal value of the buffer solution must be entered.
<i>Calibration</i> (software version 2.18 or higher)	<ul style="list-style-type: none"> ● <i>valid</i> ● <i>invalid</i> ● <i>last valid</i> ● <i>active</i> ● <i>abort</i> 	<p>Displays and determines which calibration data the measured value calculation is based on. The active calibration is displayed in the calibration history (see section 4.2.6).</p> <p><i>valid</i> indicates that a valid calibration is available. The value cannot be changed.</p> <p><i>invalid</i> is displayed if the last calibration is invalid and the sensor is blocked for measurement. In this case, you can switch to the values of the <i>last valid</i> calibration, provided a valid calibration is available in the sensor. Thus you activate the last valid calibration stored in the sensor the next time you exit the setting table with Save and quit. The next time the setting table is opened, <i>valid</i> is displayed.</p>

		<i>active</i> indicates that the sensor is being calibrated. If Cancel is selected, the active calibration procedure is canceled as soon as the setting table is exited with <i>Save and quit</i> .
<i>ORP shift</i> (only in mV measuring mode)	-100 mV ... +100 mV	You can set the ORP zero point here.
<i>Temperature adjustment</i>	-1.5 K ... +1.5 K	The temperature compensation function enables the temperature sensor to be balanced against a reference temperature measurement (displacement of the zero point by ±1.5 K). Notes: <ul style="list-style-type: none"> ● Due to the thermal capacity of the sensor, it is necessary to place it in a container with at least 2 liters of water. ● Leave the sensor in this container for at least 15 minutes, or in the case of temperature differences between the water and sensor > 10 K for at least 1 hour, while stirring occasionally. Then carry out the balancing procedure.
<i>Save and quit</i>		The system confirms the saving of the settings and the display switches to the next higher level.
<i>Quit</i>		The display switches to the next higher level without saving the new settings.

Carrying out settings

Using , switch from the measured value display to the main menu of the settings. Then navigate to the setting menu (setting table) of the sensor. The exact procedure is given in the relevant IQ SENSOR NET system operating manual.

4 Measuring / Operation

4.1 Measuring



WARNING

Contact with the sample can lead to danger to the user! Depending on the type of sample, suitable protective measures must be taken (protective clothing, protective goggles, etc.).



Note

Calibrate the combination electrode with the sensor and the measuring system before measuring and at regular intervals (depending on the application).



Note

Please pay attention to:

- the minimum immersion depth of the sensor (> 40 mm)
- the measuring range of the electrode used (see operating manual of the electrode).

4.2 Calibration

4.2.1 General information on calibration

Why calibrate?

During the operation of a pH electrode, the slope and asymmetry of the electrode changes with time. The calibration procedure determines the current slope and asymmetry of the electrode.

When to calibrate?

Calibrate before measuring and at regular intervals (depending on the application).

Calibration procedure

The *CAL TEC AUTO* calibration procedure enables a fully automatic calibration using buffer solutions. Ordering information on buffer solutions is given in chapter 6 REPLACEMENT PARTS AND ACCESSORIES.

The *CAL CON 2P* calibration procedure enables conventional two-point calibration using using 2 different buffer solutions (first buffer solution pH 7.0 ± 0.5, second buffer solution with any pH value).

The *CAL CON 1P* calibration procedure enables conventional single-point calibration with any single buffer solution.

Calibration record / calibration history

The result of a calibration is stored in the calibration record and calibration history respectively and can be viewed afterwards (see respective IQ SENSOR NET system operating manual).

Maintenance condition

During calibration the sensor is in the so-called maintenance condition. This means all linked outputs retain their momentary state. After finishing calibration the maintenance condition has to be switched off manually. For more detailed information on the maintenance condition please refer to the respective IQ SENSOR NET system operating manual.

General course of a calibration on the IQ SENSOR NET

Generally, calibration on the IQ SENSOR NET is carried out as follows. System specific details are given in the respective IQ SENSOR NET system operating manual.



**Note**

Before starting make sure the correct calibration procedure is set (see section 3.4 SENSOLYT® 700 IQ (SW) SETTING TABLE).

1	Switch to the measured value display with (M) and select the sensor to be calibrated.
2	Call up calibration with (C) . The next step switches on the maintenance condition for the sensor. A corresponding note appears on the display.
3	Confirm the note with (OK) . The maintenance condition is active. The menu-guided calibration routine starts. Follow the instructions on the display. After the calibration routine is finished, the measured value display appears again (the measured value flashes because the sensor is still in the maintenance condition).
4	If the calibration was successful, bring the sensor into the measuring position.
5	Wait for a stable measured value.
6	Switch off the maintenance condition.





4.2.2 Calibration with *CAL TEC AUTO*

Messages displayed during calibration with *CAL TEC AUTO*

Display	Explanation
<i>* Have any two technical buffer solutions ready.</i>	You can use any two different buffer solutions to do this. Confirm with  .
<i>* Rinse the sensor. * Immerse the sensor in the first buffer solution. * Wait for a stable measured value.</i>	Follow the instructions on the display. As soon as a stable measured value is reached, the next display appears.
<i>* Rinse the sensor. * Immerse the sensor in the second buffer solution. * Wait for a stable measured value.</i>	Follow the instructions on the display. As soon as a stable measured value is reached, the next display appears.
<i>Successfully calibrated. End of the CAL TEC AUTO calibration.</i>	The values determined for <i>Slope</i> and <i>Asymmetry potential</i> are displayed. The calibration is complete. Confirm with  . The display returns to the measured value display.



4.2.3 Calibration with CAL CON 2P

Messages displayed during two-point calibration with CAL CON 2P

Display	Explanation
<i>* Have buffer pH 7.0 ± 0.5 and any second buffer solution ready.</i>	You can use two buffer solutions of which the pH values according to the actual temperature are known: <ul style="list-style-type: none"> – first buffer solution pH 7,0 ± 0,5 – second buffer solution with any pH value
<i>* Rinse the sensor. * Immerse the sensor in the first buffer solution pH 7.0 ± 0.5. * Wait for a stable measured value.</i>	Follow the instructions on the display. As soon as a stable measured value is reached, the next display appears.
<i>* Enter the pH value of the first buffer solution.</i>	Select the pH value of the first buffer solution according to the displayed temperature with  and confirm with  .
<i>* Rinse the sensor. * Immerse the sensor in the second buffer solution. * Wait for a stable measured value.</i>	Follow the instructions on the display. As soon as a stable measured value is reached, the next display appears.
<i>* Enter the pH value of the second buffer solution.</i>	Select the pH value of the second buffer solution according to the displayed temperature with  and confirm with  .
<i>Successfully calibrated. End of the CAL CON 2P calibration.</i>	The values determined for <i>Slope</i> and <i>Asymmetry potential</i> are displayed. The calibration is complete. Confirm with  . The display returns to the measured value display.

4.2.4 Calibration with CAL CON 1P

Messages displayed during the single-point calibration with CAL CON 1P

Display	Explanation
<i>* Have any buffer solution ready.</i>	You can use any buffer solution the pH value of which is known at the current temperature.
<i>* Rinse the sensor. * Immerse the sensor in the buffer solution. * Wait for a stable measured value.</i>	Follow the instructions on the display. As soon as a stable measured value is reached, the next display appears.
<i>* Enter the pH value of the buffer solution.</i>	Enter the pH value with  .
<i>Confirm entered data and continue calibration</i>	Confirm with  . The measurement of the buffer solution begins.
<i>Successfully calibrated. End of the CAL CON 1P calibration.</i>	The values determined for <i>Slope</i> and <i>Asymmetry potential</i> are displayed. The calibration is complete. Confirm with  . The display returns to the measured value display.

4.2.5 Calibration result

Calibration evaluation

After calibrating the system automatically evaluates the calibration data and current state of the sensor. The asymmetry and slope are evaluated separately. The values must be within the following ranges:

Slope: -50 ... -62 mV/pH

Asymmetry: -45 mV ... +45 mV

If one of both values is outside the specified range, the calibration is evaluated as unsuccessful, i. e. the sensor could not be calibrated.

A calibration can have the following results:

Possible results of the calibration

Display after the calibration	Log book entries (meaning/actions)
Measured value display	Sensor was successfully calibrated. For the calibration data, see the calibration history.
"----"	Sensor could not be calibrated. Sensor blocked for measurement. – Service the sensor immediately (see operating manual). – View the calibration history. – Check the calibration conditions and calibration standard.



Note

Information on the contents and structure of the log book, and how to call it up, is given in the LOG BOOK chapter of the IQ SENSOR NET system operating manual.

4.2.6 Calibration history

**Calibration history
(available in the
IQ SENSOR NET
system 2020 XT only)**

MIQ/T2020		15 Aug 2007 14:11		🔒 ⚠️ ⓘ	
Calibration history of selected sensor					330
S04 Sensolyt700IQ 99160001					
Date	Slope mV/pH	Asymmetry potential mV			

03.08.2007	-55.75	0.40	o.k.		

15.08.2007	-	-	Error		
03.08.2007	-55.75	0.40	o.k.		
11.07.2007	-59.12	8.07	o.k.		
20.06.2007	-61.46	6.50	o.k.		
Tolerance	-62..-50	-45..+45			
Return ESC					

actual active
calibration

chronological list
with the last
calibrations

Fig. 4-1 Calibration history Sensolyt® 700 IQ (SW)

The calibration history contains the following information:

- Date of the calibration
- Slope [mv/pH]
- Asymmetry potential [mV]
- Rating of the calibration:
 - *o.k.*: Calibration was successful.
The new calibration values are used for the measurements.
 - *Error*: Calibration was not successful.
The Sensor is blocked for measurement.

4.2.7 Reactivation of the last valid calibration

The SensoLyt® 700 IQ (SW) enables you to reactivate the last valid calibration when needed. Thereby, it is possible to continue with measurements, when a calibration failed or it is assumed that optimal calibration conditions were not met.



Note

The reactivation of former calibration data is only a temporary solution. Please consider, that thereby possibly wrong measurement values are produced. Please check correct functioning of the sensor by performing a function check and/ or a user calibration.

Reactivating the last valid calibration data

1	Open the the setting table (see section 3.4).
2	Choose in the menu item <i>Calibration</i> the setting <i>letzte gültige</i> and quit the setting table afterwards with <i>Save and quit</i> .

5 Maintenance and changing the electrode

5.1 General maintenance instructions

The Sensolyt® 700 IQ (SW) pH/ORP sensor operates maintenance-free.



Note

Please read the maintenance of the combination electrode in the relevant operating manual of the electrode.



WARNING

**Contact with the sample can lead to danger to the user!
Depending on the type of sample, suitable protective measures must be taken (protective clothing, protective goggles, etc.).**



CAUTION

If the glass of the pH electrode breaks, there is a danger of cuts from the splinters of glass!



Note

We do not recommend unscrewing the sensor from the sensor connection cable when changing the electrode. Otherwise, moisture and/or dirt can get into the plug connection where they can cause contact problems.

If you would like to disconnect the sensor from the sensor connection cable, please note the following points:

- Before disconnecting the sensor from the SACIQ (SW) sensor connection cable, remove any larger pieces of contamination from the sensor, particularly in the area of the plug connection (brush it off in a bucket of tapwater, wash it off with a hose or wipe it off with a cloth).
- Unscrew the sensor from the SACIQ (SW) sensor connection cable.
- Always place a protective cap on the plug head of the sensor and on the SACIQ (SW) sensor connection cable so that no moisture or dirt can get into the contacting surfaces.
- In corrosive environments close the dry socket of the sensor connection cable with the SACIQ-Plug protective screw cap in order to protect the electrical contacts from corrosion. The protective cap is available as an accessory (see section 6.2 GENERAL ACCESSORIES). It is included in the standard scope of delivery of the SACIQ SW sensor connection cable.

5.2 Replacing the combination electrode

If it is necessary to replace the combination electrode, proceed as follows:

- 1 Unscrew the protective hood from the sensor.

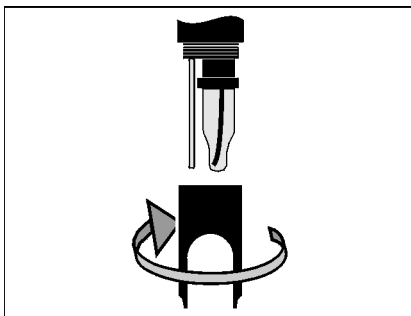

- 2 Use the protective hood as a tool to lever out the combination electrode.

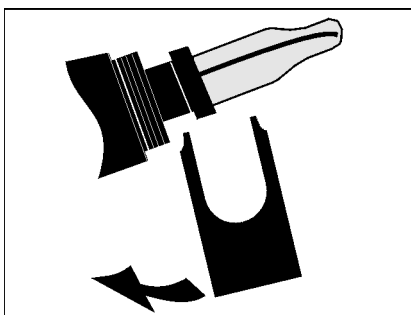

- 3 Carefully pull out the combination electrode until the plug head screwed fitting can be seen.

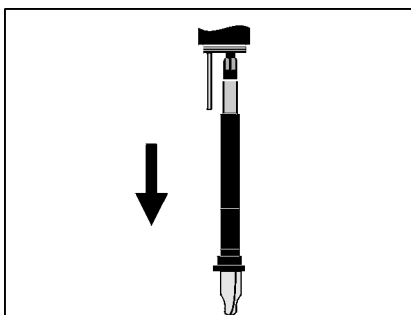

- 4 | Unscrew the combination combination electrode from the plug head socket (for disposal, see section 5.3).

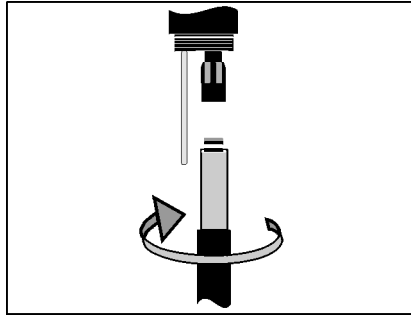

- 5 | Screw in a new combination electrode.

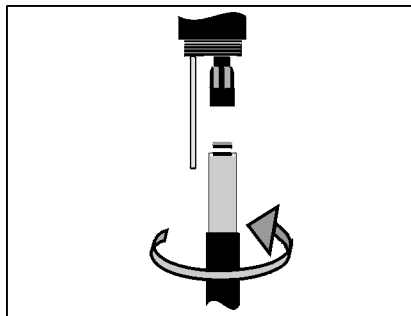

- 6 | Push the unit into the sensor up to the stop.

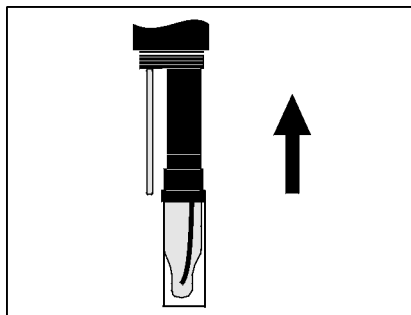

- 7 | Pull the KCl-filled plastic cap off the combination electrode for measuring.

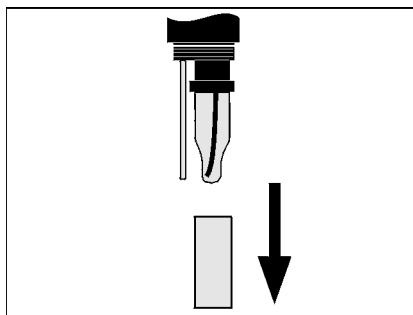

8 | Screw the protective hood onto the sensor.

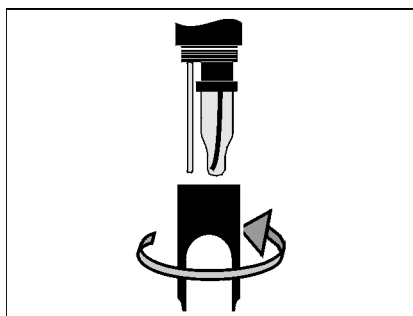

9 | Calibrate the sensor and the electrode with the measuring system (see section 4.2 CALIBRATION).

5.3 Disposal

Sensor

We recommend disposing of the sensor as electronic refuse.

Combination electrodes

If no official regulations apply to the contrary, used and defective combination electrodes can be treated as household waste.

6 Replacement parts and accessories

6.1 Combination electrodes

pH combination electrodes	Model	Order no.
	SensoLyt® SEA	109 115Y
	SensoLyt® DWA	109 119Y
	SensoLyt® ECA	109 117Y
	SensoLyt® SEA-HP	109 118Y
ORP combination electrode	SensoLyt® PtA	109 125Y

6.2 General accessories

Buffer solutions for SensoLyt® pH electrodes	Description	Model	Order no.
	pH 4 (box of 6 pints)	3821	003821
	pH 7 (box of 6 pints)	3822	003822
	pH 10 (box of 6 pints)	3823	003823
	pH assorted (2 pints ea of 4, 7, and 10)	3824	603824
Protective screw cap for sensor connection cable	Model	Order no.	
	SACIQ-Plug	480 065Y	



Note
Information on other IQ SENSOR NET accessories is given in the YSI catalog and on the Internet.

7 What to do if...

No measured value	Cause	Remedy
	<ul style="list-style-type: none"> – Sensor not connected – Unknown 	<ul style="list-style-type: none"> – Connect the sensor – Look in the log book
Measurement does not function	Cause	Remedy
	<ul style="list-style-type: none"> – Watering cap still on the electrode 	<ul style="list-style-type: none"> – Pull off watering cap and calibrate
	<ul style="list-style-type: none"> – Electrode not connected 	<ul style="list-style-type: none"> – Connect electrode
	<ul style="list-style-type: none"> – Liquid has penetrated the sensor 	<ul style="list-style-type: none"> – Sensor defective, send it back
	<ul style="list-style-type: none"> – Sensor not connected 	<ul style="list-style-type: none"> – Connect the sensor
	<ul style="list-style-type: none"> – Instrument setting incorrect 	<ul style="list-style-type: none"> – Correct instrument setting
System cannot be calibrated	Cause	Remedy
	<ul style="list-style-type: none"> – Slope of the electrode not within tolerance (see section 4.2.5) 	<ul style="list-style-type: none"> – Condition the electrode – If the slope is still outside the tolerance: replace electrode
	<ul style="list-style-type: none"> – Slope of the electrode too low 	<ul style="list-style-type: none"> – Replace electrode
	<ul style="list-style-type: none"> – Asymmetry of the electrode too high 	<ul style="list-style-type: none"> – Replace electrode
	<ul style="list-style-type: none"> – Sensor is operated with ORP electrode 	<ul style="list-style-type: none"> – Use pH electrode

Measurement provides implausible measured values

Cause	Remedy
– No calibration performed	– Calibrate
– Electrode not connected or defective	– Check electrode and electrode connection
– Electrode contaminated	– Clean electrode
– Liquid has penetrated the sensor	– Sensor defective, send it back
– Instrument setting incorrect	– Correct instrument setting (<i>Measuring mode</i> pH or mV)

8 Technical data

8.1 Measurement characteristics

Measuring principle

Potentiometric measurement using a combination electrode; Integrated microprocessor electronics, shielded 2-wire connection for power and data transmission.

Measuring range

pH	0.00 ... 14.00 pH (depending on the electrode)
ORP	-2000 mV ... +2000 mV (depending on the electrode)

Resolution

pH	0.01 pH
ORP	1 mV

Temperature measurement

Temperature sensor	integrated NTC
Measuring range	- 5 °C ... + 60 °C (23 ... 140 °F)
Accuracy	± 0.5 K
Resolution	0.1 K
Response time t_{99} of the temperature sensor	< 15 s

Temperature compensation

in the range 0 °C ... 60 °C (32 ... 140 °F)

8.2 Application characteristics

Temperature range

Measuring medium	0 °C ... + 60 °C (32 ... 140 °F)
Storage/transport	- 5 °C ... + 65 °C (23 ... 149 °F)

Allowed pH range of the test sample

4 ... 12

Pressure resistance Max. allowed overpressure (sensor including connection cable):

with installed combination electrode, SensoLyt® SEA, DWA, PtA	10 ⁶ Pa (10 bar) *
with installed combination electrode, SensoLyt® ECA	6 x10 ⁵ Pa (6 bar) *
with installed combination electrode, SensoLyt® SEA-HP	10 ⁶ Pa (10 bar) **

* temperature dependent (see safety instruction below)

** in the entire temperature range

The SensoLyt® 700 IQ (SW) meets the requirements according to article 3(3) of the directive, 97/23/EC ("pressure equipment directive").

Immersion depth

with installed combination electrode, SensoLyt® SEA, DWA, PtA	min. 40 mm; max. 100 m *
with installed combination electrode, SensoLyt® ECA	min. 40 mm; max. 60 m *
with installed combination electrode, SensoLyt® SEA-HP	min. 40 mm; max. 100 m **

* temperature dependent (see safety instruction below)

** in the entire temperature range



CAUTION

The pressure resistance of the operable pH/ORP armature can be reduced by the pressure resistance of the combination electrode. When selecting the combination electrode make sure it is suitable for the intended pressure and temperature range.

Type of protection

Sensor with installed combination electrode and including SACIQ (SW) sensor connection cable	IP 68, 10 bar (10 ⁶ Pa)
Sensor plug head connector without sensor connection cable (sensor with installed combination electrode)	IP 67

Operating position

any

Fields of application

SensoLyt 700 IQ	Stationary measurements in water/ wastewater applications
SensoLyt 700 IQ SW	Stationary measurements in seawater and brackish water, aquaculture

8.3 General data

Dimensions

SensoLyt 700 IQ:

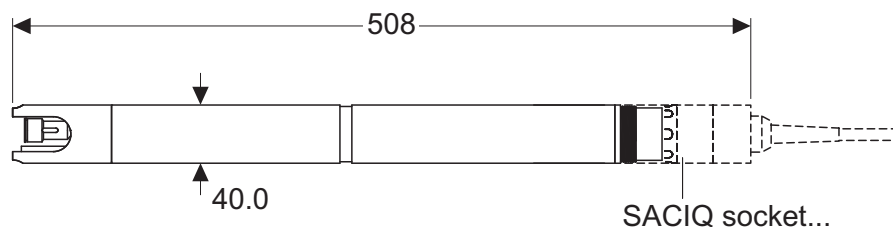

SensoLyt 700 IQ SW:

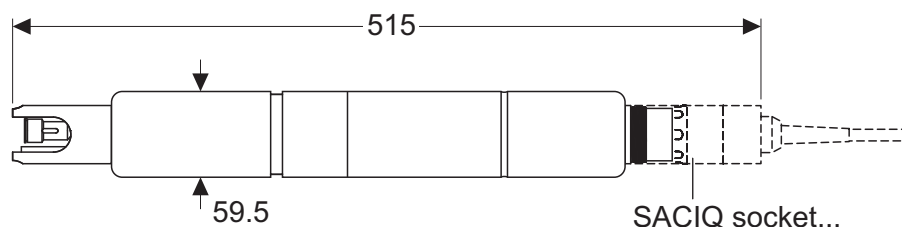

Weight (without sensor connection cable and combination electrode)

SensoLyt 700 IQ	approx. 970 g
SensoLyt 700 IQ SW	approx. 1800 g

Electrodes that can be integrated

pH combination electrodes	SensoLyt® SEA, SEA-HP, DWA, ECA
ORP combination electrodes	SensoLyt® PtA

Connection technique

Connection via the SACIQ or SACIQ SW sensor connection cable

Material

Shaft	
– SensoLyt 700 IQ	V4A stainless steel 1.4571 *
– SensoLyt 700 IQ SW	POM
Protective hood	PVC
Electrode holder	POM
Temperature sensor:	
– SensoLyt 700 IQ	V4A stainless steel 1.4571 *
– SensoLyt 700 IQ SW	V4A stainless steel 1.4571, KTL-coated

* Stainless steel can be susceptible to corrosion at chloride concentrations of ≥ 500 mg/l and more. We recommend to use SW sensors for applications in such test solutions.

Material (Continued)

Plug head housing	POM
Plug, 3-pole	ETFE (blue) Tefzel®

Automatic sensor monitoring (SensCheck function)

Function for monitoring glass breakage in the pH electrode

Instrument safety

Applicable norms	<ul style="list-style-type: none"> – EN 61010-1 – UL 3111-1 – CAN/CSA C22.2 No. 1010.1
------------------	---

8.4 Electrical data

Nominal voltage	Max. 24VDC via the IQ SENSOR NET (for more details, see chapter TECHNICAL DATA of the IQ SENSOR NET system operating manual)
Power consumption	0.2 W
Protective class	III

9 Contact Information

9.1 Ordering & Technical Support

Telephone: (800) 897-4151
(937) 767-7241
Monday through Friday, 8:00 AM to 5:00 PM ET

Fax: (937) 767-1058

Email: environmental@ysi.com

Mail: YSI Incorporated
1725 Brannum Lane
Yellow Springs, OH 45387
USA

Internet: www.ysi.com

When placing an order please have the following information available:

YSI account number (if available)	Name and Phone Number
Model number or brief description	Billing and shipping address
Quantity	Purchase Order or Credit Card

9.2 Service Information

YSI has authorized service centers throughout the United States and Internationally. For the nearest service center information, please visit www.ysi.com and click 'Support' or contact YSI Technical Support directly at 800-897-4151.

When returning a product for service, include the Product Return form with cleaning certification. The form must be completely filled out for an YSI Service Center to accept the instrument for service. The Product Return form may be downloaded at www.ysi.com and clicking on the 'Support' tab.

10 Indexes

10.1 Explanation of the messages

This chapter contains a list of all the message codes and related message texts that can occur in the log book of the IQ SENSOR NET system for the SensoLyt® 700 IQ (SW) sensor.



Note

Information on the contents and structure of the log book, and how to call it up, is given in the LOG BOOK chapter of the IQ SENSOR NET system operating manual.



Note

All Message codes of the SensoLyt® 700 IQ (SW) end up with "311".

10.1.1 Error messages

Message code	Message text
EA1311	<i>Meas. range exceeded or undercut</i> * Check process * Select other meas. range
EA2311	<i>Sensor temperature too high!</i> * Check process and application
EA3311	<i>Sensor temperature too low!</i> * Check process and application
EC1311	<i>Sensor could not be calibrated, Sensor blocked for measurement</i> * Check calibration conditions and calibration standard * View calibration history * Service sensor immediately (see operating manual)
EI1311	<i>Operational voltage too low</i> * Check installation and cable lengths, Follow installation instructions * Power unit(s) overloaded, add power unit(s) * Check terminal and module connections * Defective components, replace components
EI2311	<i>Operational voltage too low, no operation possible</i> * Check installation and cable lengths, Follow installation instructions * Power unit(s) overloaded, add power unit(s) * Check terminal and module connections * Defective components, replace components

Message code	Message text
ES1311	<i>Component hardware defective * Contact service</i>
ESA311	<i>SensCheck: pH electrode defective, glass broken * Replace pH electrode</i>

10.1.2 Info messages

Message code	Message text
IC1311	<i>Sensor has been successfully calibrated * For calibration data, see calibration history</i>
IC4311	<i>Last valid calibration has been activated. Make sure the sensor operates correctly.</i>
II1311	<i>Language not available, Default language German * Contact service</i>

10.2 Status info

The status info is a coded piece of information on the current status of a sensor. Each sensor sends this status info to the controller. The status info of sensors consists of 32 bits, each of which can have the value 0 or 1.

Status info,
general structure

0	1	2	3	4	5	6	7	8	9	10	11	12	13	14	15
1	0	0	0	0	0	0	0	0	0	0	0	0	0	0	0
16	17	18	19	20	21	22	23	24	25	26	27	28	29	30	31

(general)

(internal)

The bits 0 - 15 are reserved for general information.
The bits 16 - 21 are reserved for internal service information.

You obtain the status info:

- via a manual query in the *Einstellungen/Settings/Service/List of all components* menu (see system operating manual)
- by an automated query
 - of a superordinate process control (e. g. when connected to the Profibus)
 - from the IQ Data Server (see IQ SENSOR NET Software Pack operating manual)



Note

The evaluation of the status info, e.g. in the case of an automated query, has to be made individually for each bit.

Status info
SensoLyt® 700 IQ (SW)

Status bit	Explanation
Bit 0	<i>Component hardware defective</i>
Bit 1	<i>SensCheck: pH electrode defective, glass broken</i>
Bit 2-31	-



a xylem brand

1725 Brannum Lane
Yellow Springs, Ohio 45387 USA
+1 937-767-7241
800-765-4974 (US)
FAX (937) 767-1058
Email: environmental@ysi.com
Internet: www.ysi.com